

Tuesday

Private, practical, and purpose-build for solo focus.



Technical Information

Capacity

1-2 People

Warranty

Two-year warranty

Furniture

1x upholstered booth seat & HPL meeting table

Acoustic

28db NIC ASTM E596

Footprint

1115mm x 1180mm

Ventilation

- Airflow: 35-85m³/hr
- 1x silent, built-in adjustable fan

Lighting

- Light sources: 1x 6W LED (dimmable)
- Colour temperature: 4000K (adjustable)
- Colour Rendering Index (CRI): 95+
- Reading Lamp

Dimensions

- Internal: W: 1000mm D: 1070mm H: 1960mm
- External: W: 1115mm D: 1180mm H: 2260mm
- Doorway: W: 1100mm
- Weight: 250kg

Power and Data

- Internal: x1 GPO, x1 USB-C, and 1x USB-A (above desk)
- External: Power inlet, located on back left-hand side. Includes a standard 1.8 metre long cable
- Power consumption: 11W
- Operation: Motion sensor operated with manual controls

Design

- Eco-friendly materials and packaging
- Mount monitors on the wall or table

Certifications

- AS/NZS 3000: Australian and New Zealand wiring rules for safe electrical installations
- ISO 23351-1 & ASTM E596: Measures the pod's ability to reduce speech levels for privacy
- FireMark: Recognised by Australian authorities as a mark of fire safety for passive fire products
- RCM: Ensures products comply with both safety and electromagnetic compatibility (EMC) regulations in Australia and New Zealand
- BIFMA Level 2: Sustainability standard for furniture, evaluating environmental, social, and health impacts

Finishes

Light Palette

Ashen

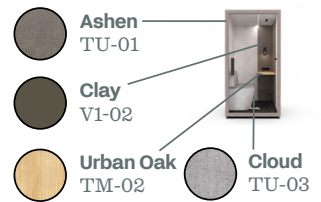

Dark Palette

Storm

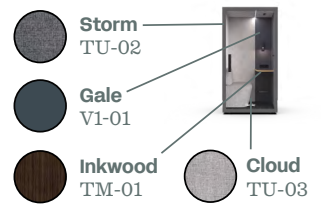

Carpet

(anti-static)



Drawings

*Dimensions shown are for reference only and do not constitute a technical drawing. A minimum clearance of 40mm is required on all sides for installation and ventilation purposes, and 60mm clearance required on top for fan ventilation.

Internal:

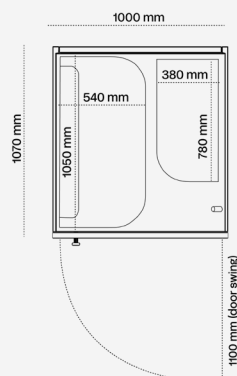

External:

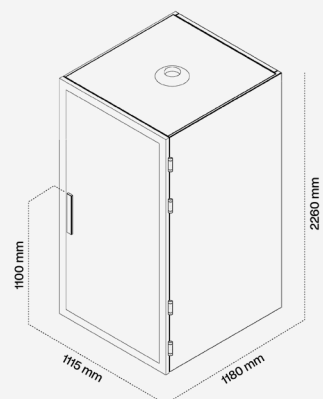
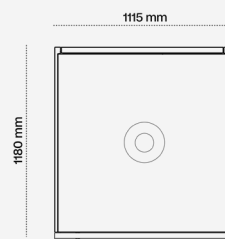

Tuesday+

Big on space, low on fuss-
Collaboration made simple.



Technical Information

Capacity

2-4 People

Warranty

Two-year warranty

Furniture

2x upholstered booth seats & meeting table

Acoustic

28db NIC ASTM E596

Footprint

2200mm x 1180mm

Ventilation

- Airflow: 70-174m³/hr
- 2x silent, built-in adjustable fan

Lighting

- Light sources: 2x 6w LED (dimnable)
- Colour temperature: 4000K (adjustable)
- Colour Rendering Index (CRI): 95+
- Reading Lamp

Dimensions

- Internal: W: 2100mm D: 1070mm H: 1960mm
- External: W: 2200mm D: 1180mm H: 2260mm
- Doorway: W: 1100mm
- Weight: 459kg

Power and Data

- Internal: x2 GPO, x1 USB-C, and 2x USB (above desk)
- External: Power inlet, located on back left-hand side. Includes a standard 1.8 metre long cable
- Power consumption: 11W
- Operation: Motion sensor operated with manual controls

Design

- Eco-friendly materials and packaging
- Mount monitors on the wall or table

Certifications

- AS/NZS 3000: Australian and New Zealand wiring rules for safe electrical installations
- ISO 23351-1 & ASTM E596: Measures the pod's ability to reduce speech levels for privacy
- FireMark: Recognised by Australian authorities as a mark of fire safety for passive fire products
- RCM: Ensures products comply with both safety and electromagnetic compatibility (EMC) regulations in Australia and New Zealand
- BIFMA Level 2: Sustainability standard for furniture, evaluating environmental, social, and health impacts

Finishes

Light Palette

Ashen

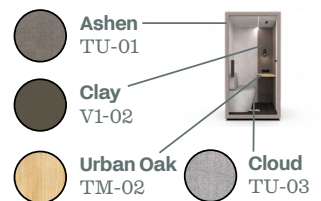

Dark Palette

Storm

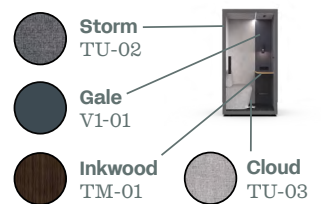

Carpet

(anti-static)



Drawings

*Dimensions shown are for reference only and do not constitute a technical drawing. A minimum clearance of 40mm is required on all sides for installation and ventilation purposes, and 60mm clearance required on top for fan ventilation.

Internal:

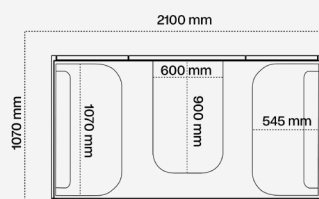

External:

